



CROCHET | SKILL LEVEL: EASY

ABBREVIATIONS

Approx = Approximately
Beg = Begin(ning)
Ch = Chain(s)
Dc = Double crochet
Hdc = Half double crochet
Rem = Remain(ing)
Rep = Repeat
Rnd(s) = Round(s)

RS = Right side
Sc = Single crochet
Sl st = Slip stitch
Sp(s) = Space(s)
St(s) = Stitch(es)
Tog = Together
WS = Wrong side

Looking for the original pattern? You can find it [here](#).

MATERIALS

Red Heart® Super Saver® O'Go® (Solids: 7 oz/198 g; 364 yds/333 m; Prints: 5 oz/141 g; 236 yds/215 m)

Main Color (MC) Dusty Gray (7140) **7 O'Gos**

Contrast A,B,C,D & E: Rainbow (7192) **2 O'Gos**



Size U.S. G/6 (4 mm) crochet hook **or size needed to obtain gauge**.
 Stitch marker. Yarn needle. 3" [7.5 cm] thick piece of foam 16" x 24" [40.5 x 61 cm]. 4" [10 cm] thick piece of foam 16" x 24" [40.5 x 61 cm].
 Quilt batting. Hot glue gun and glue sticks.

MEASUREMENTS

Blanket: Approx 16" [40.5 cm] square.

Couch: Approx 24" [61 cm] long x 16" [40.5 cm] deep x 12" [30.5 cm] tall.

GAUGE

15 sc and 16 rows = 4" [10 cm].

INSTRUCTIONS

Notes:

- To begin working with the O'Go format, carefully cut plastic tie where the ends of the O'Go meet.
- Pull tie to remove.

- For Blanket, colors can be easily separated by gently pulling apart and cutting at the color transition. Each color is ready to use. Follow color guide shown in Materials section for O'Go (Contrast A, B, C, D and E). You may find it helpful to place each color section in its own resealable (zip lock) bag and label each bag A, B, C, D and E.
- Ch 3 at beg of row/rnd counts as dc.
- Ch 2 at beg of row/rnd **does not** count as st.
- Join all rnds with sl st to top of ch 3.

BLANKET (Make 3 Granny Square Motifs each in Contrast A, B, C and E, and make 4 in D).

Ch 4. Join with sl st to first ch to form ring.

1st rnd: Ch 3. 2 dc in ring. Ch 2. (3 dc in ring. Ch 2) 3 times. Join.

2nd rnd: Sl st in each of next 2 dc and next ch-2 sp. Ch 3. (2 dc. Ch 2. 3 dc) all in first ch-2 sp. [(Ch 1. 3 dc. Ch 2. 3 dc) all in next ch-2 sp] 3 times. Ch 1. Join.

3rd rnd: Sl st in each of next 2 dc and next ch-2 sp. Ch 3. (2 dc. Ch 2. 3 dc) all in first corner ch-2 sp. Ch 1. 3 dc in next ch-1 sp. [(Ch 1. 3 dc. Ch 2. 3 dc) all in next in corner ch-2 sp. Ch 1. 3 dc in next ch-1 sp] 3 times. Ch 1. Join.

4th rnd: Ch 1. 1 sc in each of first 3 dc. (1 sc. Ch 2. 1 sc) all in first corner ch-2 sp. *(1 sc in each of next 3 dc. 1 sc in next ch-1 sp) twice.** 1 sc in each of next 3 dc. (1 sc. Ch 2. 1 sc) all in next corner ch-2 sp. Rep from * twice more, then from * to ** once. Join. Fasten off.

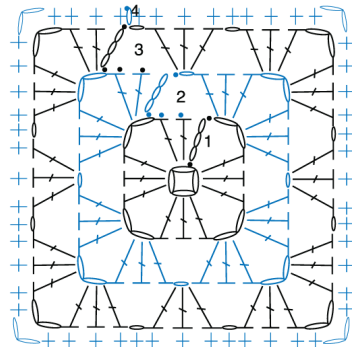

GRANNY SQUARE MOTIF

STITCH KEY

- = chain (ch)
- = slip stitch (sl st)
- ⌋ = double crochet (dc)
- ⌋ = single crochet (sc)

Assembly

Sew Squares tog into 4 Strips, with 4 Squares in each Strip (see assembly diagram). Sew Strips tog.

Assembly Diagram



Edging: With RS facing, join MC with sl st to any corner ch-2 sp. Work 1 rnd of sc evenly around Blanket, working 3 sc in each corner. Join with sl st to first sc. Fasten off.

COUCH

Couch Cushions – Part A (make 2)
**With MC, ch 46.

1st row: 1 sc in 2nd ch from hook. *1 dc in next ch. 1 sc in next ch. Rep from * to end of chain. Turn. 45 sts.

2nd row: (RS). Ch 2. 1 dc in first st. *1 sc in next st. 1 dc in next st. Rep from * to end of row. Turn.

3rd row: Ch 1. 1 sc in first st. *1 dc in next st. 1 sc in next st. Rep from * to end of row. Turn. Rep 2nd and 3rd rows until work from beg measures 3" [7.5 cm], ending on a RS row.**

Next row: (WS). Sl st in each of first 12 sts. Ch 2 (**does not** count as st). 1 dc in first st. *1 sc in next st. 1 dc in next st. Rep from * to end of row. Turn. 33 sts.

Next row: Ch 1. 1 sc in first st. *1 dc in next st. 1 sc in next st. Rep from * to end of row. Turn.

Next row: Ch 2. 1 dc in first st. *1 sc in next st. 1 dc in next st. Rep from * to end of row. Turn.

Rep last 2 rows until work from beg measures 13" [33 cm]. Fasten off.

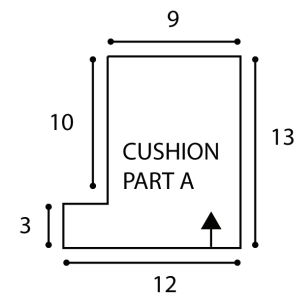

Couch Cushions – Part B (make 2)
Work from ** to ** as given for Couch Cushions – Part A.

Next row: (WS) Ch 2. 1 dc in first st. *1 sc in next st. 1 dc in next st. Rep from * to last 12 sts. **Turn.** Leave rem sts unworked.

Next row: Ch 1. 1 sc in first st. *1 dc in next st. 1 sc in next st. Rep from * to end of row. Turn. 33 sts.

Next row: Ch 2. 1 dc in first st. *1 sc in next st. 1 dc in next st. Rep from * to end of row. Turn.

Rep last 2 rows until work from beg measures 13" [33 cm]. Fasten off.

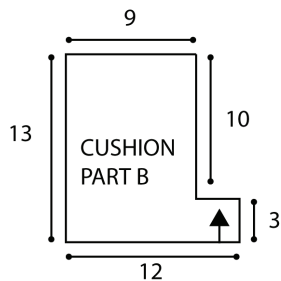

Finishing Couch Cushions

Cut 6 pieces of Quilt batting to match dimensions of Cushion.

With WS facing each other, place one Part A and one Part B tog.

With RS of Part A facing, join MC with sl st to any corner of Cushion.

Ch 1. *Working through both thicknesses*, work sc evenly around perimeter of Cushion, working 3 sc in each corner, stopping to insert 3 layers of quilt batting into Cushion before joining last side. Join with sl st to first sc. Fasten off.

Rep for second cushion, with RS of Part B facing.

Base of Couch

With MC, ch 16.

1st row: 1 sc in 2nd ch from hook. *1 dc in next ch. 1 sc in next ch. Rep from * to end of chain. Turn. 15 sts.

2nd row: (RS). Ch 2. 1 dc in first st. *1 sc in next st. 1 dc in next st. Rep from * to end of row. Turn.

3rd row: Ch 1. 1 sc in first st. *1 dc in next st. 1 sc in next st. Rep from * to end of row. Turn.

Rep last 2 rows until work from beg measures 80" [203 cm]. Fasten off.

Couch Seat and Back Cushion

With MC, ch 92.

1st row: 1 sc in 2nd ch from hook. *1 dc in next ch. 1 sc in next ch. Rep from * to end of chain. Turn. 91 sts.

2nd row: (RS). Ch 2. 1 dc in first st. *1 sc in next st. 1 dc in next st. Rep from * to end of row. Turn.

3rd row: Ch 1. 1 sc in first st. *1 dc in next st. 1 sc in next st. Rep from * to end of row. Turn.

Rep 2nd and 3rd rows until work from beg measures 3" [7.5 cm], ending on a WS row.

Next row: Sl st in each of first 12 sts. Ch 2 (**does not** count as st). 1 dc in first st. *1 sc in next st. 1 dc in next st. Rep from * to last 12 sts. **Turn.** Leave rem sts unworked.

Proceed as follows:

Next row: Ch 1. 1 sc in first st. *1 dc in next st. 1 sc in next st. Rep from * to end of row. Turn. 67 sts.

Next row: (RS). Ch 2. 1 dc in first st. *1 sc in next st. 1 dc in next st. Rep from * to end of row. Turn.

Rep last 2 rows until work from beg measures 16" [40.5 cm], ending on a RS row.

Increase rows:

1st row: (WS). Ch 13. 1 sc in 2nd ch from hook. 1 dc in next ch. (1 sc in next ch. 1 dc in next ch) 5 times. 1 sc in first st. *1 dc in next st. 1 sc in next st. Rep from * to end of row. Turn.

2nd row: (RS). Ch 14. 1 dc in 3rd ch from hook. 1 sc in next ch. (1 dc in next ch. 1 sc in next ch) 5 times. 1 dc in next st. *1 sc in next st. 1 dc in next st. Rep from * to end of row. Turn. 91 sts.

3rd row: Ch 1. 1 sc in first st. *1 dc in next st. 1 sc in next st. Rep from * to end of row. Turn.

4th row: (RS). Ch 2. 1 dc in first st. *1 sc in next st. 1 dc in next st. Rep from * to end of row. Turn. Rep last 2 rows until work from beg 21" [53.5 cm]. Fasten off.

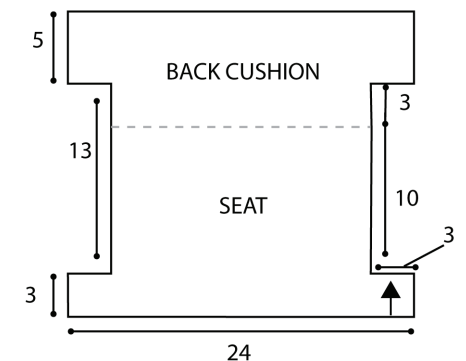

Back of Couch and Top

With MC, ch 116.

1st row: (RS). 1 sc in 2nd ch from hook. *1 dc in next ch. 1 sc in next ch. Rep from * to end of chain. Turn. 115 sts.

2nd row: Ch 2. 1 dc in first sc. *1 sc in next dc. 1 dc in next sc. Rep from * to end of row. Turn.

3rd row: Ch 1. 1 sc in first dc. *1 dc in next sc. 1 sc in next dc. Rep from * to end of row. Turn.

Rep last 2 rows until work from beg measures 8" [20.5 cm], ending on a WS row.

Next row: (RS). Sl st in each of first 12 sts. Ch 1. 1 sc in next dc. *1 dc in next sc. 1 sc in next dc. Rep from * to last 12 sts. **Turn.** Leave rem sts unworked.

Next row: Ch 2 (does not count as st). 1 dc in first sc. *1 sc in next dc. 1 dc in next sc. Rep from * to end of row. Turn. 91 sts.

Next row: Ch 1. 1 sc in first dc. *1 dc in next sc. Rep from * to end of row. Turn. Rep last 2 rows until work from beg

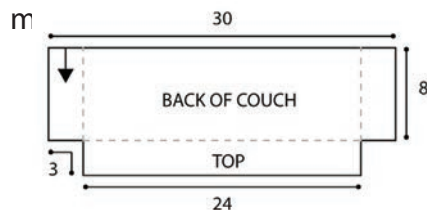

Armrests (make 2)

With MC, ch 38.

1st row: (RS). 1 sc in 2nd ch from hook. *1 dc in next ch. 1 sc in next ch. Rep from * to end of chain. Turn. 37 sts.

2nd row: Ch 2. 1 dc in first st. *1 sc in next st. 1 dc in next st. Rep from * to end of row. Turn.

3rd row: Ch 1. 1 sc in first st. *1 dc in next st. 1 sc in next st. Rep from * to end of row. Turn.

Rep last 2 rows until work from beg measures 9" [23 cm]. Fasten off.

Armrests Ends (make 2)

With MC, ch 12.

1st row: 1 sc in 2nd ch from hook. *1 dc in next ch. 1 sc in next ch. Rep from * to end of chain. Turn. 11 sts.

2nd row: (RS). Ch 2. 1 dc in first st. *1 sc in next st. 1 dc in next st. Rep from * to end of row. Turn.

3rd row: Ch 1. 1 sc in first st. *1 dc in next st. 1 sc in next st. Rep from * to end of row. Turn.

Rep last 2 rows until work from beg measures 3" [7.5 cm]. Fasten off.

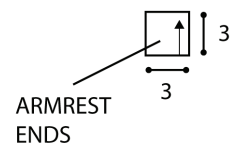

Dust Ruffle

Note: Do not separate shades for Dust Ruffle. After cutting and removing plastic tie, start crocheting!

With Contrast A, ch 212.

1st row: 1 hdc in 3rd ch from hook. 1 hdc in each ch to end of chain. Turn. 210 sts,

2nd row: Ch 2. 3 dc in each st to end of row. Turn. 630 sts.

3rd row: Ch 1. 1 dc in each st to end of row. Fasten off.

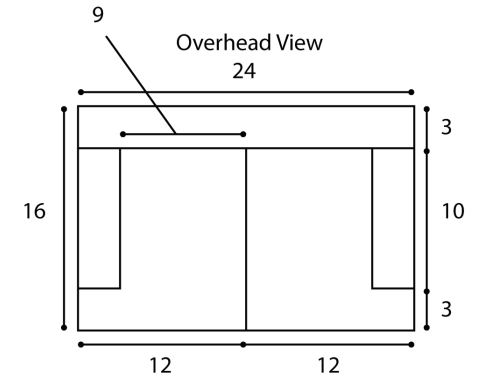

Bottom

With MC, ch 92.

1st row: 1 sc in 2nd ch from hook. *1 dc in next ch. 1 sc in next ch. Rep from * to end of chain. Turn. 91 sts.

2nd row: (RS). Ch 2. 1 dc in first st. *1 sc in next st. 1 dc in next st. Rep from * to end of row. Turn.

3rd row: Ch 1. 1 sc in first st. *1 dc in next st. 1 sc in next st. Rep from * to end of row. Turn.

Rep last 2 rows until work from beg measures 16" [40.5 cm]. Fasten off.

Foam Foundation

Note: When cutting foam, using a serrated (bread) knife will allow greater control.

Cut the following pieces from 3" [7.5 cm] thick foam:

Piece A: Back

One piece measuring 8" x 24" [20 x 61 cm].

Pieces B and C: Armrests

Two pieces measuring 3" x 10" [7.5 x 25.5 cm].

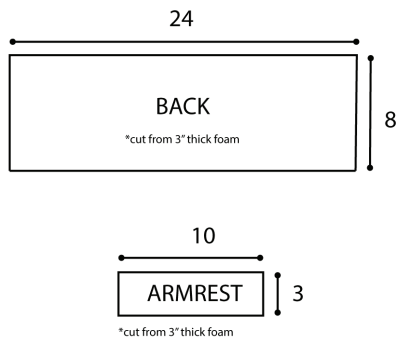

Using hot glue gun, assemble pieces on 4" [10"] slab of foam (D) measuring 16" x 24" [40.5 x 61 cm] as shown in diagram.

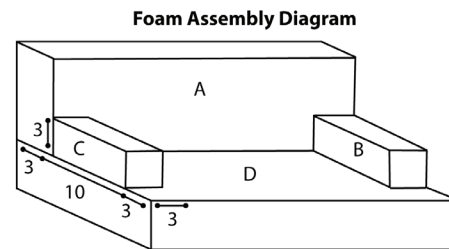

Couch Cover Assembly

See Assembly Diagram.

Sew Back/Top section to Back Cushion and Seat as indicated in purple.

Sew Armrests to Seat as indicated in blue.

Sew corners of Back as indicated in red.

Sew Back to Back Cushion as indicated in grey.

Sew Armrest to Back Cushion and Back as indicated in orange and yellow.

Sew Armrest Ends to Armrest and seat as indicated in pink.

Sew Base to perimeter of Couch as indicated in green.

Sew Dust Ruffle to Base as shown in photo, covering front and sides.

Affix assembled Couch Cover to foam foundation. Tack with yarn and yarn needle or hot glue if needed to secure cover.

Sew Bottom to lower edge of Base.

Assembly Diagram

