



CROCHET | SKILL LEVEL: **EASY**

ABBREVIATIONS

Ch = Chain(s)	Rnd(s) = Round(s)	St(s) = Stitch(es)
Dc = Double crochet	RS = Right side	Tog = Together
Hdc = Half double crochet	Sc = Single crochet	Tr = Treble crochet
Rep = Repeat	Sl st = Slip stitch	Yoh = Yarn over hook
	Sp(s) = Space(s)	

SIZES

To fit bust measurement

XS/S 28-34" [71-86.5 cm]
M/L 36-42" [91.5-106.5 cm]
XL/2XL 44-48" [112.5-122 cm]
3/4/5XL 52-62" [132-157.5 cm]

Finished bust measurement

XS/S 37" [94 cm]
M/L 45" [114.5 cm]
XL/2XL 54" [137 cm]
3/4/5XL 63" [160 cm]

GAUGE

Motif A = 3" [7.5 cm] square.
 Motif B = 3¾" [9.5 cm] square.
 Motif C = 4½" [11 cm] square.

INSTRUCTIONS

The instructions are written for smaller size. If changes are necessary for larger size the instructions will be written thus (). Numbers for each size are shown in the same color throughout the pattern. When only one number is given in black, it applies to both sizes.

Size XS/S only: Make 65 Motifs B.
 Make 6 Half Motifs B.

Size M/L only: Make 65 Motifs C.
 Make 6 Half Motifs C.

Size XL/2XL only: Make 76 Motifs C.
 Make 6 Half Motifs C.

Size 3/4/5XL only: Make 85 Motifs C.
 Make 6 Half Motifs C.

MATERIALS

Bernat® Softee® Cotton™ (4.2 oz/120 g; 254 yds/232 m)

Sizes	XS/S	M/L	XL/2XL	3/4/5XL	
Pool Green (69010)	4	5	6	7	balls

Size U.S. 7 (4.5 mm) crochet hook **or size needed to obtain gauge.**
 Yarn needle.

MOTIF A

Ch 6. Join with sl st to first ch to form a ring. See diagram on page 3.

1st rnd: Ch 1. 12 sc in ring. Join with sl st to first sc.

2nd rnd: Ch 3. 1 dc in same sp as last sl st - counts as CL2. *Ch 2. (*Yoh and draw up a loop. Yoh and draw through 2 loops on hook*) twice in next st. *Yoh and draw through all loops on hook* - CL2 made. Rep from * around, ending with ch 2. Join with sl st to top of ch 3. 12 CL2.

3rd rnd: Ch 2. 1 hdc in same sp as last sl st. *Ch 2. Skip next ch-2 sp. (CL2. Ch 1. CL2. Ch 3. CL2. Ch 1. CL2) all in next ch-2 sp. Ch 2.** Skip next ch-2 sp. 1 hdc in top of next CL2. Rep from * twice more, then from * to ** once. Join with sl st to first hdc. Fasten off.

MOTIF B

Ch 6. Join with sl st to first ch to form a ring. See diagram on page 3.

1st rnd: Ch 3. 1 dc in ring - counts as CL2. *Ch 2. (*Yoh and draw up a loop. Yoh and draw through 2 loops on hook*) twice in ring. *Yoh and draw through all loops on hook* - CL2 made. Rep from * 10 times more. Ch 2. Join with sl st to top of ch 3. 12 CL2.

2nd rnd: Sl st in next dc. Sl st in next ch-2 sp. Ch 3. 1 dc in same sp as last sl st - counts as CL2. *Ch 3. CL2 in next ch-2 sp. Rep from * around, ending with ch 3. Join with sl st to top of ch 3.

3rd rnd: Ch 2. 1 hdc in same sp as last sl st. *Ch 3. Skip next ch-3 sp. (CL2. Ch 2. CL2. Ch 3. CL2. Ch 2. CL2) all in next ch-3 sp. Ch 3.** Skip next ch-3 sp. 1 hdc in top of next CL2. Rep from * twice more, then from * to ** once. Join with sl st to first hdc. Fasten off.

MOTIF C

Ch 6. Join with sl st to first ch to form a ring. See diagram on page 3.

1st rnd: Ch 4. 1 tr in ring (counts as Tr2tog). *Ch 2. [*Yoh and draw up a loop. Yoh and draw through 2 loops on hook*] twice in ring. *Yoh and draw through all loops on hook* - Tr2tog made. Rep from * 10 times more. Ch 2. Join with sl st to top of ch 3. 12 Tr2tog.

2nd rnd: Sl st in next tr. Sl st in next ch-2 sp. Ch 3. (*Yoh and draw up a loop. Yoh and draw through 2 loops on hook*) twice in same sp. *Yoh and draw through all loops on hook* - counts as CL3. *Ch 3. (*Yoh and draw up a loop. Yoh and draw through*

2 loops on hook) 3 times in next ch-2 sp. *Yoh and draw through all loops on hook* - CL3 made. Rep from * around, ending with ch 3. Join with sl st to top of ch 3.

3rd rnd: Ch 2. 1 hdc in same sp as last sl st. *Ch 3. Skip next ch-3 sp. (CL3. Ch 2. CL3. Ch 4. CL3. Ch 2. CL3) all in next ch-3 sp. Ch 3.** Skip next ch-3 sp. 1 hdc in top of next CL3. Rep from * twice more, then from * to ** once. Join with sl st to first hdc. Fasten off.

HALF MOTIF A

Ch 6. Join with sl st to first ch to form a ring. See diagram on page 3.

1st row: Ch 1. 7 sc in ring. Turn.

2nd row: Ch 5 (counts as dc and ch 2). (CL2 in next sc. Ch 2) 6 times. 1 dc in last sc. Turn.

3rd row: Ch 4 (counts as dc and ch 1). (CL2. Ch 1. CL2) in first ch-2 sp. Ch 2. Skip next ch-2 sp. 1 hdc in top of next CL2. Ch 2. Skip next ch-2 sp. (CL2. Ch 1. CL2. Ch 3. CL2. Ch 1. CL2) all in next ch-2 sp. Ch 2. Skip next ch-2 sp. 1 hdc in top of next CL2. Ch 2. Skip next ch-2 sp. [(CL2. Ch 1) twice. 1 dc] in top of turning ch. Fasten off.

HALF MOTIF B

Ch 6. Join with sl st to first ch to form a ring. See diagram on page 3.

1st row: Ch 3. 1 dc in ring - counts as CL2. (Ch 2. CL2 in ring) 6 times. Turn. 7 CL2.

2nd row: Ch 6 (counts as dc and ch 3). (CL2 in next ch-2 sp. Ch 3) 6 times. 1 dc in top of ch 3. Turn.

3rd row: Ch 4 (counts as dc and ch 1). (CL2. Ch 2. CL2) in first ch-3 sp. Ch 3. Skip next ch-3 sp. 1 hdc in top of next CL2. Ch 3. Skip next ch-3 sp. (CL2. Ch 2. CL2. Ch 3. CL2. Ch 2. CL2) all in next ch-3 sp. Ch 3. Skip next ch-3 sp. 1 hdc in top of next CL2. Ch 3. Skip next ch-3 sp. (CL2. Ch 2. CL2. Ch 1. 1 dc) all in top of turning ch. Fasten off.

HALF MOTIF C

Ch 6. Join with sl st to first ch to form a ring. See diagram on page 3.

1st row: Ch 4. 1 tr in ring - counts as Tr2tog. (Ch 2. Tr2tog in ring) 6 times. Turn.

2nd row: Ch 6 (counts as dc and ch 3). (CL3 in next ch-2 sp. Ch 3) 6 times. 1 dc in 3rd ch of ch 4. Turn.

3rd row: Ch 4 (counts as dc and ch 1). (CL3. Ch 2. CL3) in first ch-3 sp. Ch 3. Skip next ch-3 sp. 1 hdc in top of next CL3. Ch 3. Skip next

ch-3 sp. (CL3. Ch 2. CL3. Ch 4. CL3. Ch 2. CL3) all in next ch-3 sp. Ch 3. Skip next ch-3 sp. 1 hdc in top of next CL3. Ch 3. Skip next ch-3 sp. (CL3. Ch 2. CL3. Ch 1. 1 dc) all in top of turning ch. Fasten off.

FINISHING

Join into Front, Back and Sleeves as shown in diagrams on page 4.

Pin garment pieces to measurements. Cover with a damp cloth, leaving cloth to dry.

1st rnd: With RS facing, join yarn with sl st at left side seam. Ch 1. Work **14 (17-17-17)** sc across lower edge of each Motif around. Join with sl st to first sc. **140 (170-204-238)** sc.

Next rnd: Ch 4 (counts as dc and ch 1). Skip next sc. *1 dc in next sc. Ch 1. Skip next sc. Rep from * around, ending with sl st in 3rd ch of ch 4.









Next rnd: Sl st in next ch-1 sp. Ch 4 (counts as dc and ch 1). *1 dc in next ch-1 sp. Ch 1. Rep from * around, ending with sl st in 3rd ch of ch 4.

Next rnd: Sl st in next ch-1 sp. Ch 3. 1 dc in same sp – counts as CL2. *Ch 1. CL2 in next ch-1 sp. Rep from * around, ending with ch 1. Join with sl st to top of ch 3.

Next rnd: Sl st in next ch-1 sp. Ch 1. (1 sc. Ch 3. 1 dc) all in same sp. *(1 sc. Ch 3. 1 dc) all in next ch-1 sp. Rep from * around. Join with sl st to first sc. Fasten off.

Neck edging: With RS facing, join yarn with sl st at left shoulder and work **48 (52-56-60)** sc evenly around neck edge. Join with sl st to first sc. Fasten off.

STITCH KEY

-  = chain (ch)
-  = slip stitch (sl st)
-  = single crochet (sc)
-  = half double crochet (hdc)
-  = double crochet (dc)
-  = treble crochet (tr)
-  = CL2
-  = CL3
-  = treble crochet 2 together (tr2tog)

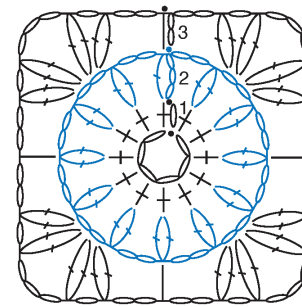

MOTIF A

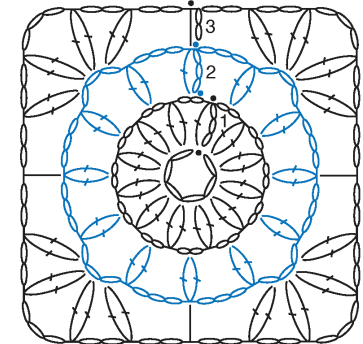

MOTIF B

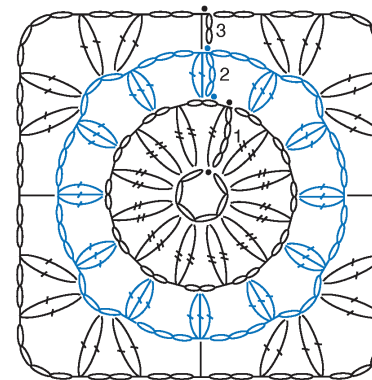

MOTIF C

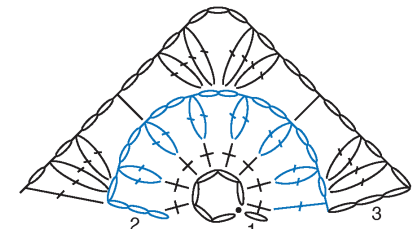

HALF MOTIF A

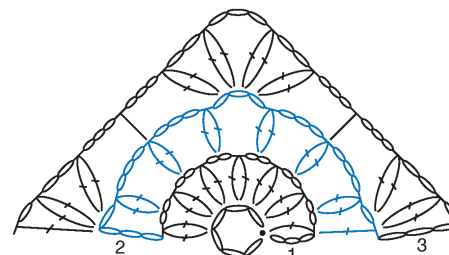

HALF MOTIF B

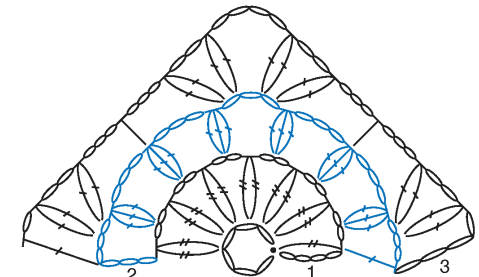

HALF MOTIF C

Sleeve Assembly

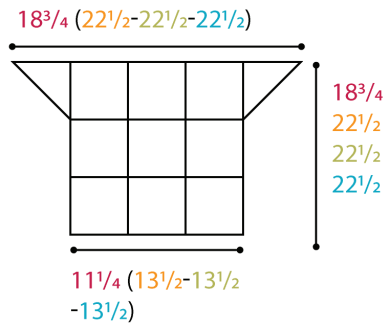

Back Assembly - XS/S (M/L)

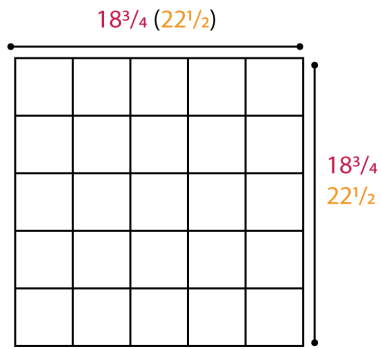

Front Assembly - XS/S (M/L)

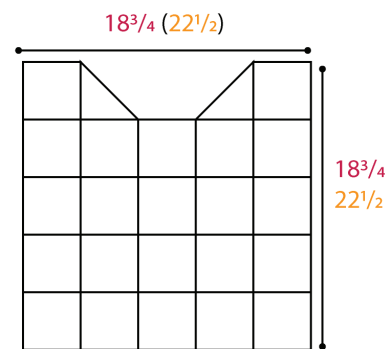

Front Assembly - XL/2XL

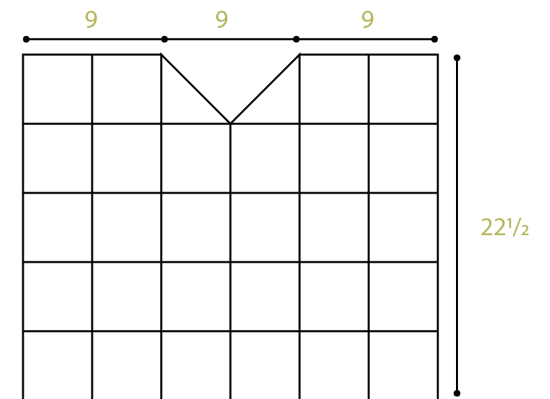

Back Assembly - 3/4/5XL
31¹/₂

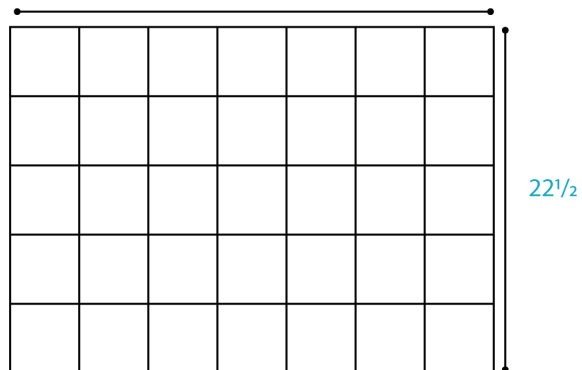

Front Assembly - 3/4/5XL

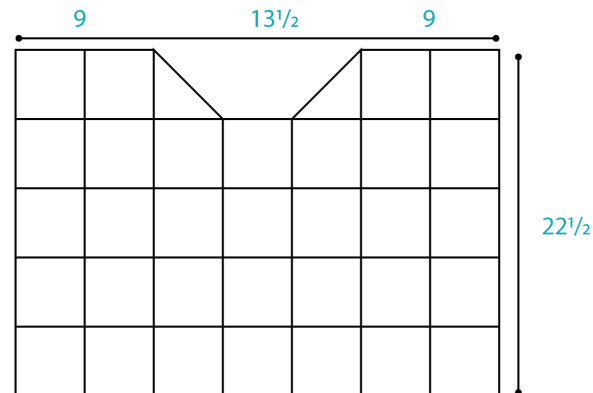

Back Assembly - XL/2XL

